



BOTTISTOP

ROTO - JOLLY



LAFAL

SISTEMI DI ACCATAMENTO BARRIQUES E REMUAGE AUTOMATICI
SYSTEMS OF STACKING ARRANGEMENTS BARRIQUES AND REMUAGE

L'AZIENDA - THE COMPANY

Azienda nata nei primi '800 come bottega artigiana di fabbro ferraio Fratelli Franchini. Prosegue fino all'immediato dopoguerra con la stessa attività. Si sviluppa e cresce ampliando le attività alle costruzioni metalliche in genere, serramentistica, saldatura dell'alluminio e carrozzerie industriali.

Nel 1980 cambia nome e diventa LAFAL snc di Franchini proseguendo e specializzandosi nei vari settori con l'inserimento di macchinari a controllo numerico robotizzati nelle varie fasi delle lavorazioni. Da ultimo si specializza nell'accatastamento palettizzabile delle botti costruendo il "Bottistop".

The Company was founded in early 1800 by the FRATELLI FRANCHINI. It started as a blacksmith's workshop, active till the end of 2nd world war. Afterwards the company develops rapidly extending its activities to iron works, aluminium welding and industrial bodyworks.

In 1980 the name changes to LAFAL S.n.c. di Franchini. The company grows specializing in different fields with the introduction of new technologies. It now presents the "Bottistop" to properly stack barrels.



LAFAL

BOTTISTOP

SISTEMI DI ACCATAMENTO
BARRIQUES
REALIZZATI TOTALMENTE
IN ALLUMINIO

BARREL STACKING
SYSTEMS
CONSTRUCTED COMPLETELY
IN ALUMINIUM

Con **BOTTISTOP** potrete sfruttare al meglio gli spazi delle Vostre cantine aumentando la capacità, rendendole più sicure e ordinate. Il materiale in alluminio ad alta resistenza è frutto di una attenta progettazione, rendendo così resistente e sicuro il **BOTTISTOP**. Le sagome circolari e una leggera inclinazione avvolgono perfettamente il profilo della barriques, garantendo un'ottima stabilità anche in condizioni gravose, inoltre la struttura del **BOTTISTOP** permette qualsiasi tipo di movimentazione con macchine operatrici.

***BOTTISTOP** is a new cellar organizer and space saver. Built in aluminium alloy to give high strength, safety and easy care, it is the result of a careful design. The peculiar shape holds the barrel perfectly giving stability even with heavy loads. **BOTTISTOP** structure lends itself to easy moving and transport.*

ROTO - JOLLY

SISTEMI AUTOMATICI
DI REMUAGE

AUTOMATIC RIDDLING
SYSTEMS

Apparecchiatura concepita per la rimozione e la precipitazione del deposito secondo il metodo classico. Costruzione semplice e robusta in acciaio galvanizzato a caldo per evitare ogni problema di corrosione. Carico e scarico delle casse con un semplice carrello elevatore, anche del tipo manuale. Possibilità di personalizzare i movimenti del "Remuage" con semplice programmazione del software. I contenitori **JOLLY-CO** sono la soluzione ideale per tutte le cantine che producono metodo classico perchè ottengono un notevole risparmio di movimentazione delle bottiglie. Costruito in acciaio galvanizzato a caldo per evitare ogni problema di corrosione. È possibile accatastarlo a qualsiasi cesta commerciale.

*Machine created for the removal and precipitation of deposits in wine using traditional champenois. Simple and robust construction. To avoid problems of corrosion, cages are made in carbon steel hot dipped in zinc. Loading and unloading cages with a simple forklift, even manual types. Personalized movement settings for Riddling with easy to use software. The **JOLLY-CO** containers are the ideal solution for all wineries that produce traditional champenois wine thanks to the considerable reduction of bottle movement obtained in riddling cycles. To avoid problems of corrosion, cages are made in carbon steel hot dipped in zinc. Can be stacked with any type of similar container on the market.*



Barriques da 225/300 - Tonneaux da 350/500 lt

Uso:

Viene usato alla base delle cataste, è dotato di tappi in p.v.c. per migliorare l'appoggio al pavimento senza intaccarlo.

Materiale:

- Alluminio anodizzato argento (standard)
- Alluminio verniciato a polveri
- Versione anche in acciaio inox

Use:

It is designed to be used at the stack bottom, fitted with rubber pugs for a better stability and no floor damage.

Material:

- Anodized aluminium, silver color (standard)
- Polyester powder coated aluminium
- Available in stainless steel

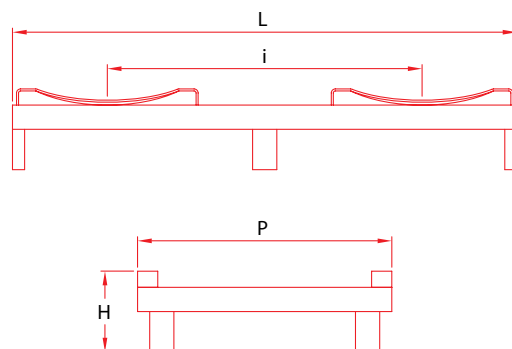

Barriques da 225/300 lt

LUNGHEZZA · LENGTH	(L)	1.250 mm
INTERASSE · WHEELBASE	(I)	790 mm
LARGHEZZA · WIDTH	(P)	630 mm
ALTEZZA · HEIGHT	(H)	210 mm
TARA · TARE	(Kg)	9
PORTATA max · FLOW	(Kg)	3.000

Tonneaux da 350/500 lt

LUNGHEZZA · LENGTH	(L)	1.470 mm
INTERASSE · WHEELBASE	(I)	1.000 mm
LARGHEZZA · WIDTH	(P)	790 mm
ALTEZZA · HEIGHT	(H)	210 mm
TARA · TARE	(Kg)	11
PORTATA max · FLOW	(Kg)	3.000



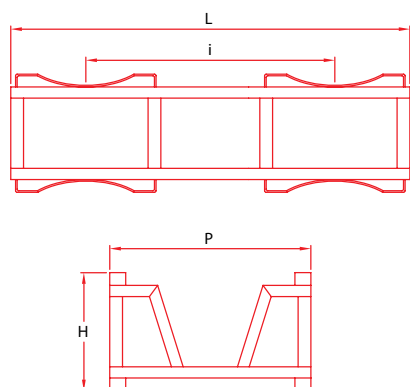

Barriques da 225/300 - Tonneaux da 350/500 lt

Uso:

È il più versatile dei **BOTTISTOP**. È stato studiato nella forma e nell'altezza per permettere un agevole accesso alla barrique sottostante per le varie lavorazioni di rabbocco, prelievi e bontage.

Materiale:

- Alluminio anodizzato argento (standard)
- Alluminio verniciato a polveri

Use:

*It is the most important **BOTTISTOP** solution. Shape and height are designed to give an easy access to the barrel to work in place.*

Material:

- Anodized aluminium, silver color (standard)
- Polyester powder coated aluminium

Barriques da 225/300 lt

LUNGHEZZA · LENGTH	(L)	1.250 mm
INTERASSE · WHEELBASE	(l)	790 mm
LARGHEZZA · WIDTH	(P)	630 mm
ALTEZZA · HEIGHT	(H)	370 mm
TARA · TARE	(Kg)	12
PORTATA max · FLOW	(Kg)	3.000

Tonneaux da 350/500 lt

LUNGHEZZA · LENGTH	(L)	1.470 mm
INTERASSE · WHEELBASE	(l)	1.000 mm
LARGHEZZA · WIDTH	(P)	790 mm
ALTEZZA · HEIGHT	(H)	350 mm
TARA · TARE	(Kg)	14
PORTATA max · FLOW	(Kg)	3.000



Barriques da 225/300 lt

Uso:

È stato studiato per poter movimentare le cataste anche con transpallet oltre che con carrello elevatore. Permette un agevole accesso alla barrique sottostante per varie lavorazioni di rabbocco, prelievi e batonage.

Materiale:

- Alluminio anodizzato argento (standard)
- Alluminio verniciato a polveri
- Versione anche in acciaio inox

Use:

It is designed for stacks to be moved with fork lift, also with fixed forks, and for having an easy access to the barrel to work the wine in place.

Material:

- Anodized aluminium, silver color (standard)
- Polyester powder coated aluminium
- Available in stainless steel

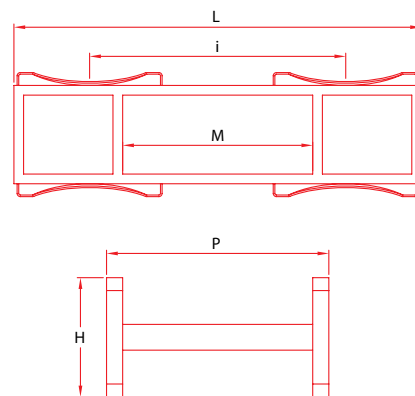

Barriques da 225/300 lt

LUNGHEZZA · LENGTH	(L)	1.265 mm
INTERASSE · WHEELBASE	(I)	790 mm
LARGHEZZA · WIDTH	(P)	690 mm
ALTEZZA · HEIGHT	(H)	385 mm
TARA · TARE	(Kg)	12
PORTATA max · FLOW	(Kg)	2.500
INTERASSE MONTANTE · FLOW	(M)	590 mm



RIALZATO TRANSPALLET SAGOMATO

BOTTISTOP

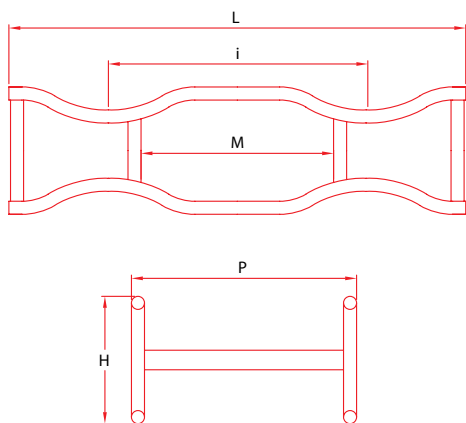

Barriques da 225/300 - Tonneaux da 350/500 lt

Uso:

È stato studiato per poter movimentare le cataste anche con transpallet oltre che con carrello elevatore. Permette un agevole accesso alla barrique sottostante per varie lavorazioni di rabbocco, prelievi e batonage.

Materiale:

- Alluminio anodizzato argento (standard)
- Alluminio verniciato a polveri

Use:

It is designed for stacks to be moved fork lift, also with fixed forks, and having an easy access to the barrel to work the wine in place.

Material:

- Anodized aluminium, silver color (standard)
- Polyester powder coated aluminium

Barriques da 225/300 lt

LUNGHEZZA · LENGTH	(L)	1.400 mm
INTERASSE · WHEELBASE	(I)	790 mm
LARGHEZZA · WIDTH	(P)	690 mm
ALTEZZA · HEIGHT	(H)	390 mm
TARA · TARE	(Kg)	11
PORTATA max · FLOW	(Kg)	3000
INTERASSE MONTANTE · FLOW	(M)	590 mm

Tonneaux da 350/500 lt

LUNGHEZZA · LENGTH	(L)	1.660 mm
INTERASSE · WHEELBASE	(I)	980 mm
LARGHEZZA · WIDTH	(P)	715 mm
ALTEZZA · HEIGHT	(H)	395 mm
TARA · TARE	(Kg)	13
PORTATA max · FLOW	(Kg)	3.000
INTERASSE MONTANTE · FLOW	(M)	680 mm



BOTTISTOP

Barriques da 225/300 - Tonneaux da 350/500 lt

Uso:

È stato studiato per ridurre notevolmente i tempi di movimentazione delle barriques. Permette un'efficace batonage, in quanto la barrique può ruotare di 360°. Consente di eseguire tutte le operazioni di riempimento, svuotamento, colmataura, lavaggio in loco senza rimuovere la barriques.

Materiale:

- Alluminio verniciato a polveri, Rosso Ral 3005

**CONSTRUITO TOTALMENTE IN ALLUMINIO
RUOTE CON CUSCINETTO E VITERIA IN ACCIAIO INOX**

Use:

It has been studied to considerably reduce and simplify the movement of the barriques. It enables an efficient batonage due to the fact that the barriques can rotate around 360°. It allows all the operations of filling, emptying and cleaning in place to be carried out without removing the barriques.

Material:

- Polyester powder coated aluminium, Red Ral 3005

**CONSTRUCTED TOTALLY IN ALUMINIUM,
WHEELS WITH BEARING AND LIVES IN STAINLESS STEEL**



Vaschetta raccogli liquido - Drip tray



Slitta per inserimento barriques - Insert slide tool



**SISTEMA DI REGOLAZIONE
DELLA RUOTA BREVETTATO**

**PATENTED WHEEL
ADJUSTMENT SYSTEM**



ESEMPI DI ACCATASTAMENTO - EXAMPLES OF STACKING ARRANGEMENTS

BARRIQUES DA 225 LT

_Piramide

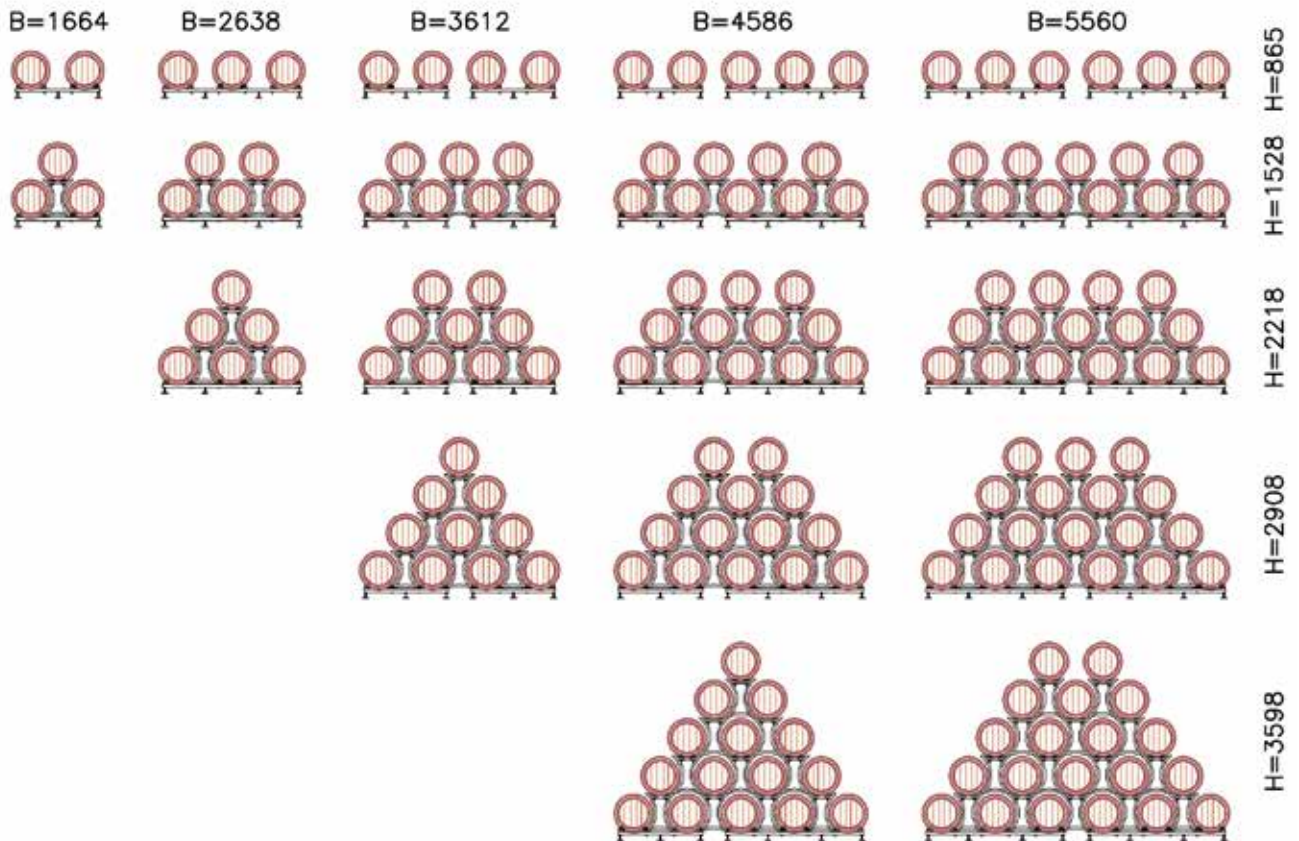

_Verticale

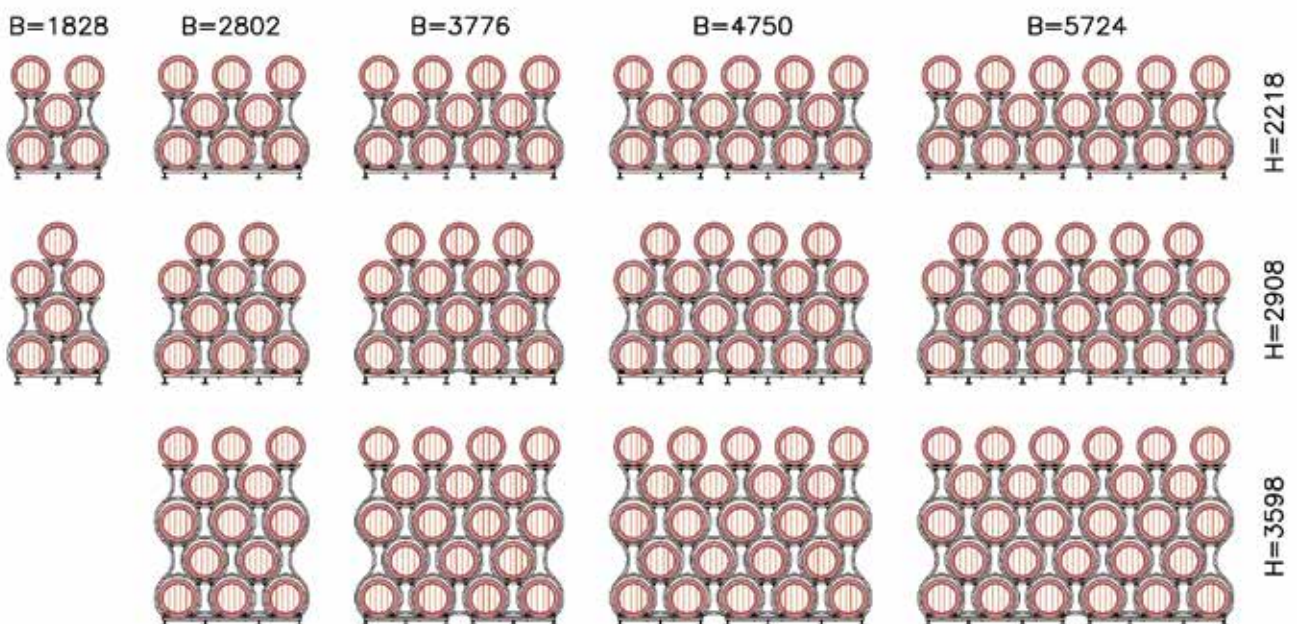

TONNEAUX DA 350 LT

_Piramide

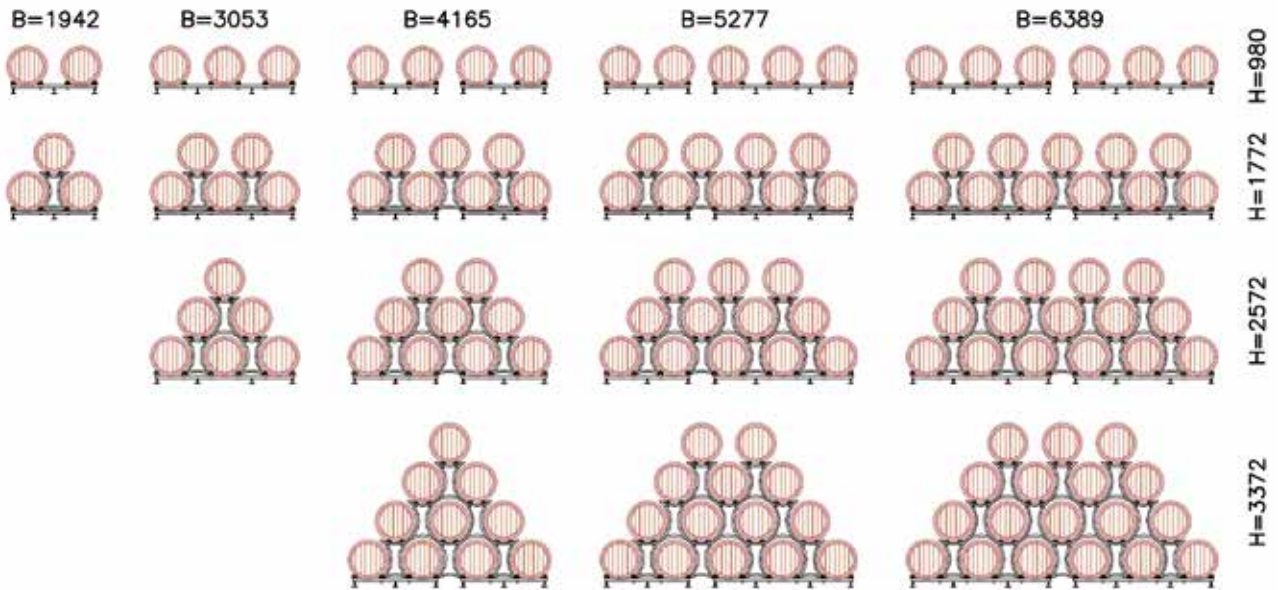

_Verticale

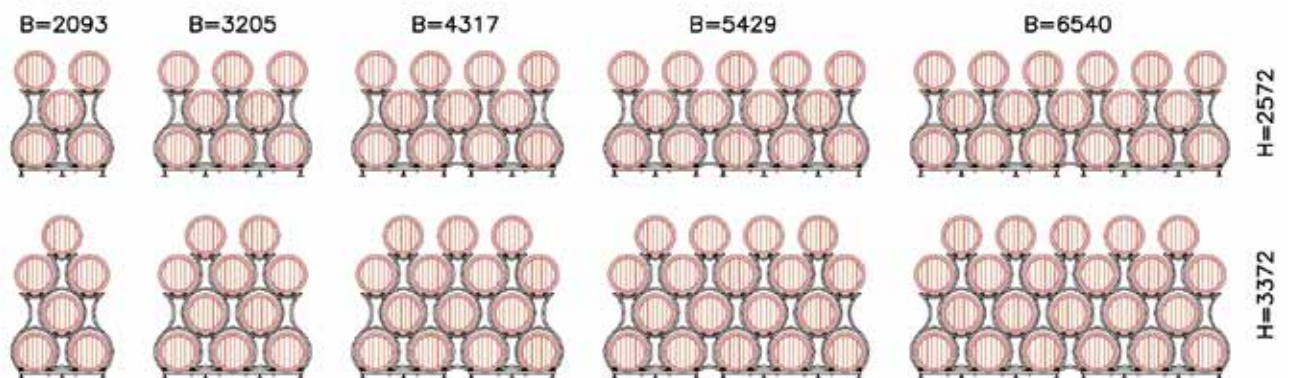

ESEMPI DI ACCATASTAMENTO - *EXAMPLES OF STACKING ARRANGEMENTS*

TONNEAUX DA 500 LT

_Piramide

B=2208



B=3466



B=4725



B=5983

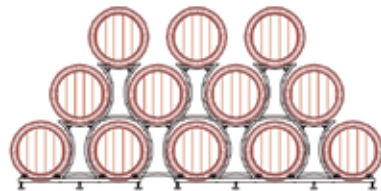
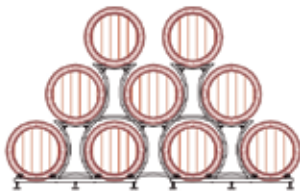
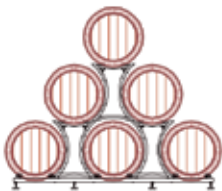
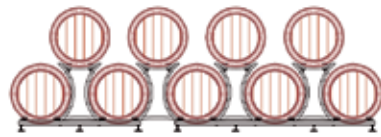
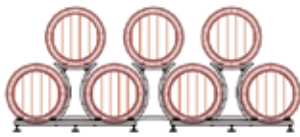
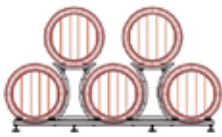

H=1087

H=1998

H=2918

_Verticale

B=2208



B=3605

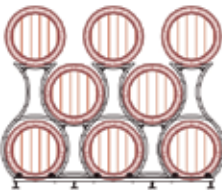

B=4863

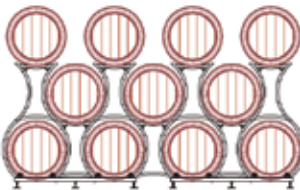

B=6121

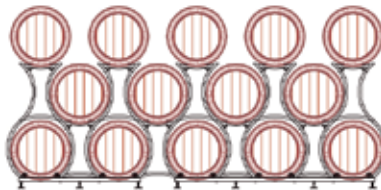

H=2918

BOTTISTOP

Barriques da 225/300 - Tonneaux da 350/500 lt

Uso:

Nasce dall'esperienza del **BOTTISTOP ROTATIVO BIS**, offre gli stessi vantaggi, rendendo più pratico l'accesso alla barriques sottostante, inoltre dà la possibilità anche di eseguire cataste circolari.

Materiale:

- Alluminio verniciato a polveri, grigio scuro bucciato

Use:

*Created from years of experience with **BOTTISTOP ROTATIVO BIS** this system offers the same advantages but with easier access to the lower level barrels. This system also makes it possible to build circular stacking arrangements.*

Material:

- Polyester powder coated aluminium, dark gray dimpled



Esempio catasta diritta - Example of linear stacking arrangement



Esempio catasta circolare - Example of curved stacking arrangement



ROTATIVO BIS



BARRIQUES DA 225 LT

_Piramide

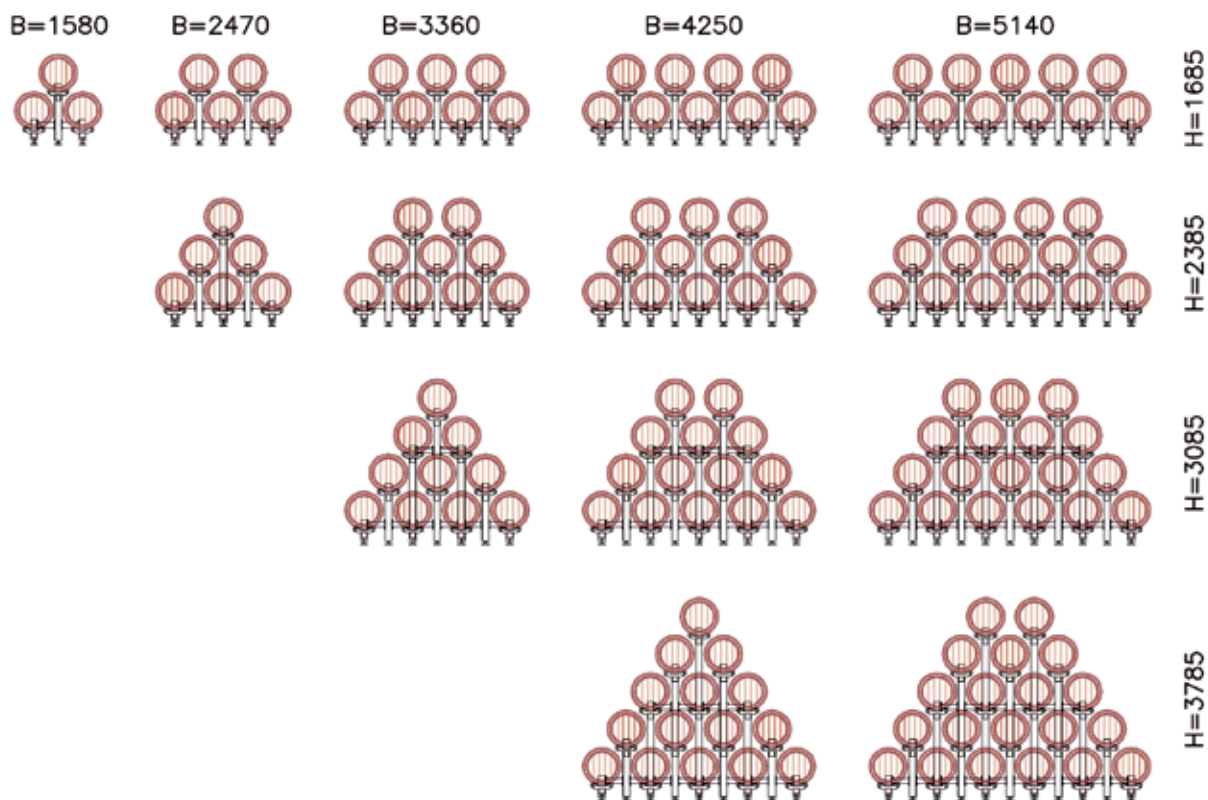

_Verticale

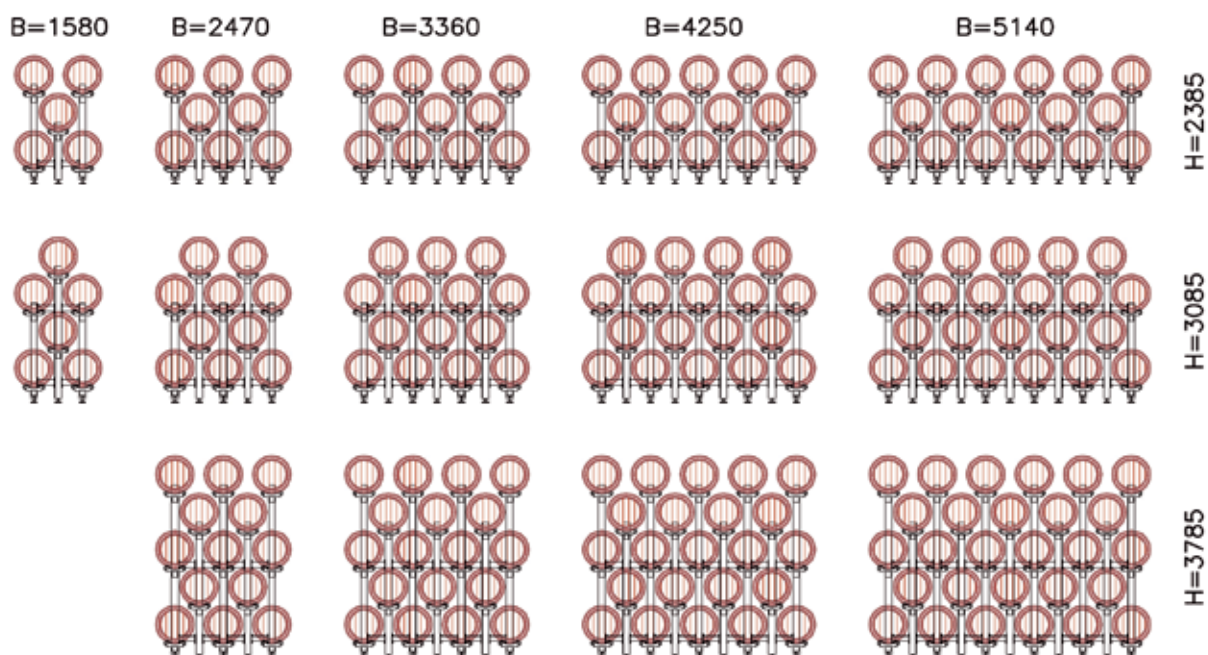

ESEMPI DI ACCATASTAMENTO - EXAMPLES OF STACKING ARRANGEMENTS

TONNEAUX DA 300 LT

_Piramide

B=1790



B=2810



B=3830



B=4850



B=5870



H=1772



H=2472

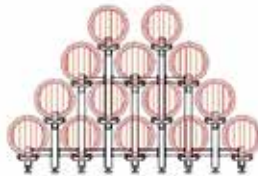

H=3172

_Verticale

B=1790



B=2810



B=3830



B=4850



B=5870



H=2472



H=3172

ESEMPI DI ACCATAMENTO - EXAMPLES OF STACKING ARRANGEMENTS

TONNEAUX DA 500 LT

_Piramide

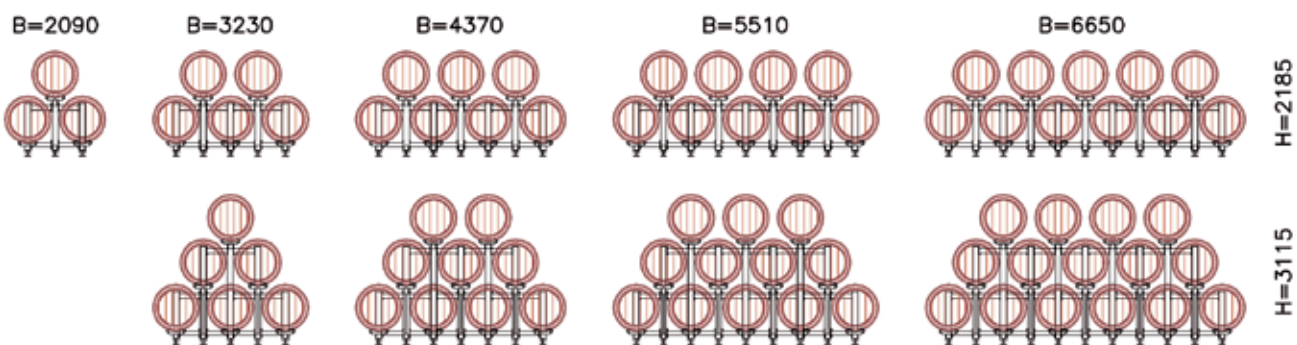

ROTATIVO SINGOLO TRANSPALLET 225/500 LT

BOTTISTOP



Uso Vaschetta - Use of drip tray



SOLLEVATORE BARRIQUES - BARREL STACKER



Consigliato per una quantità approssimativa di 30.000 bottiglie/annue
Recommended for annual production of 30.000 bottles

Uso:

Apparecchiatura concepita per la rimozione e la precipitazione del deposito secondo il metodo classico. Carico e scarico delle casse con un semplice carrello elevatore, anche del tipo manuale. Possibilità di personalizzare i movimenti del "Remuage" con semplice programmazione del software.

Materiale:

Costruzione semplice e robusta in acciaio galvanizzato a caldo per evitare ogni problema di corrosione.

Use:

Machine created for the removal and precipitation of deposits in wine using traditional champenois. Loading and unloading cages with a simple forklift, even manual types. Personalized movement settings for Riddling with easy to use software.

Material:

Simple and robust construction. To avoid problems of corrosion, cages are made in carbon steel hot dipped in zinc.



DISPOSIZIONE AD UNA CASSA - ONE CAGE SYSTEM

DUE

Consigliato per una quantità approssimativa di 60.000 bottiglie/annue
Recommended for annual production of 60.000 bottles

Uso:

Apparecchiatura concepita per la rimozione e la precipitazione del deposito secondo il metodo classico. Carico e scarico delle casse con un semplice carrello elevatore, anche del tipo manuale. Possibilità di personalizzare i movimenti del "Remuage" con semplice programmazione del software. Possibilità di sovrapporre i due macchinari.

Materiale:

Costruzione semplice e robusta in acciaio galvanizzato a caldo per evitare ogni problema di corrosione.

Use:

Machine created for the removal and precipitation of deposits in wine using traditional champenois. Loading and unloading cages with a simple forklift, even manual types. Personalized movement settings for Riddling with easy to use software. Machines can be vertically stacked.

Material:

Simple and robust construction. To avoid problems of corrosion, cages are made in carbon steel hot dipped in zinc.

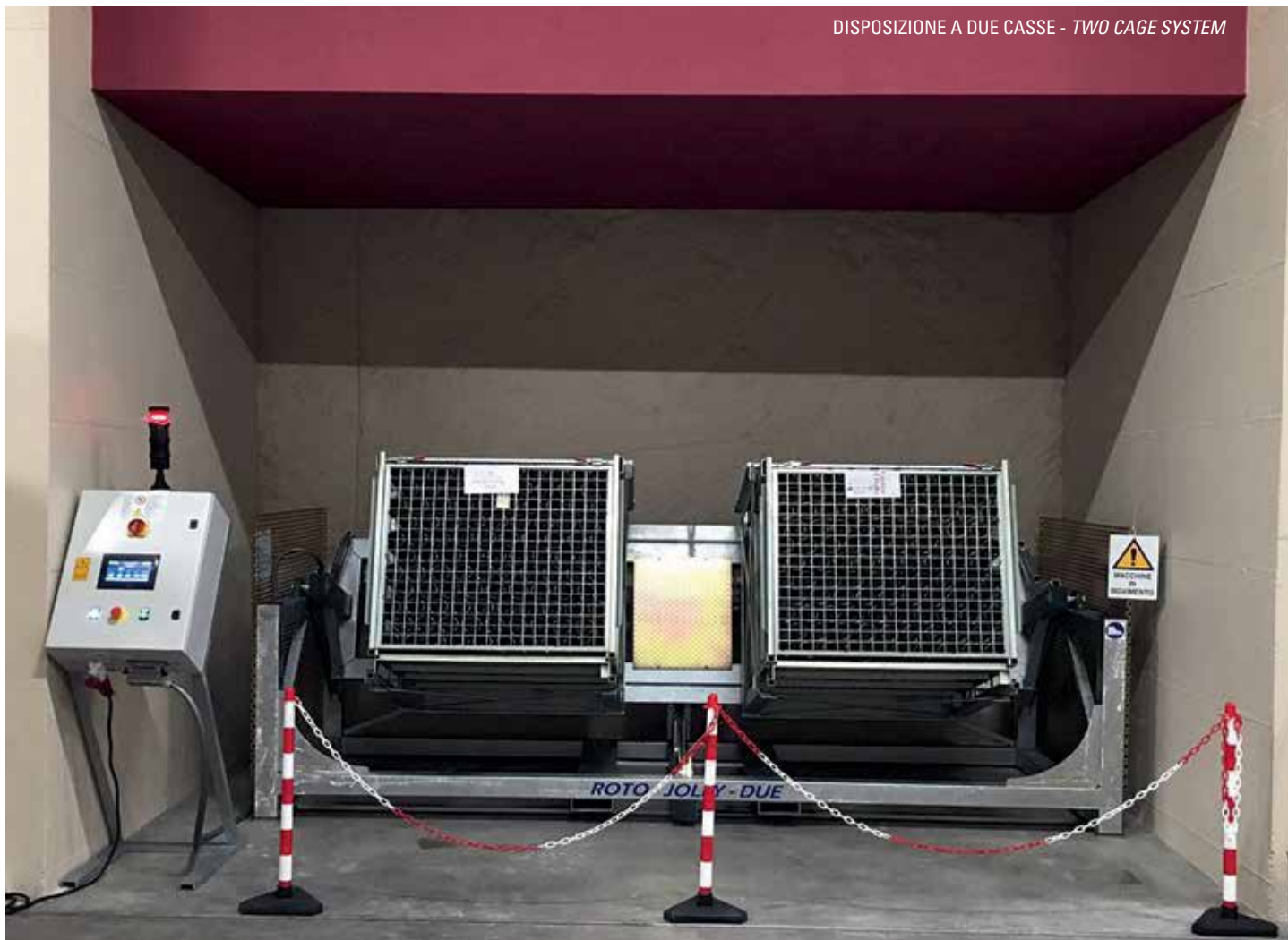

Consigliato per una quantità approssimativa di 120.000 bottiglie/annue
Recommended for annual production of 120.000 bottles

Uso:

Apparecchiatura concepita per la rimozione e la precipitazione del deposito secondo il metodo classico. Carico e scarico delle casse con un semplice carrello elevatore, anche del tipo manuale. Possibilità di personalizzare i movimenti del "Remuage" con semplice programmazione del software. Possibilità di sovrapporre i due macchinari.

Materiale:

Costruzione semplice e robusta in acciaio galvanizzato a caldo per evitare ogni problema di corrosione.

Use:

Machine created for the removal and precipitation of deposits in wine using traditional champenois. Loading and unloading cages with a simple forklift, even manual types. Personalized movement settings for Riddling with easy to use software. Possible stacking of machines.

Material:

Simple and robust construction. To avoid problems of corrosion, cages are made in carbon steel hot dipped in zinc.



DISPOSIZIONE A QUATTRO CASSE - FOUR CAGE SYSTEM

CESTONE PER REMUAGE



Il contenitore che si adatta ad ogni uso in cantina
The container that adapts to many uses in wineries.

Uso:

I contenitori **JOLLY-CO** sono la soluzione ideale per tutte le cantine che producono metodo classico perchè ottengono un notevole risparmio di movimentazione delle bottiglie. È possibile accatastarlo a qualsiasi cesta commerciale.

Materiale:

Costruito in acciaio galvanizzato a caldo per evitare ogni problema di corrosione.

Use:

The **JOLLY-CO** containers are the ideal solution for all wineries that produce traditional champenois wine thanks to the considerable reduction of bottle movement obtained in riddling cycles.

Material:

To avoid problems of corrosion, cages are made in carbon steel hot dipped in zinc.



RIPIEGHEVOLE E SOVRAPPONIBILE
FOLDABLE AND STACKABLE



JOLLY-CO-ROSSI

CESTE PER AFFINAMENTO DEI VINI ROSSI CAGES FOR THE AGING OF RED WINE

Uso:

I contenitori **JOLLY-CO-ROSSI** sono gabbie componibili in acciaio zincato destinate al contenimento di bottiglie di vino rosso per le operazioni di rotazione e di stoccaggio.

Materiale:

Costruito in acciaio galvanizzato a caldo per evitare ogni problema di corrosione.

Use:

The **Jolly-Co Rossi** modular cage, completely galvanized, is designed for the storage of red wines for operations of tipping and horizontal storage.

Material:

To avoid problems of corrosion, cages are made in carbon steel hot dipped in zinc.



ROTO

GIRA CESTE PER JOLLY-CO ROSSI CAGE TIPPING UNIT FOR JOLLY-CO ROSSI

Uso:

Il giraceste **ROTO** esegue la rotazione di 90° di ceste riempite con bottiglie in vetro piene di vino.

Materiale:

Costruito in acciaio galvanizzato a caldo per evitare ogni problema di corrosione.

Use:

The cage tipping unit **ROTO** tips the cage 90° from vertical position to horizontal position for storing.

Material:

To avoid problems of corrosion, cages are made in carbon steel hot dipped in zinc.



SEDE OPERATIVA - HEADQUARTERS



LAFAL





LAFAL

KTW GmbH & Co. KG
Deidesheim
www.k-t-w.com